

Profilati estrusi in lega d'alluminio per Cassonetti Luminosi



95121 Catania - Italy
Uff. ed Amm.ne: Via Alfredo Agosta sn, Zona Industriale
Tel. (+39) 095.360894 - 095.350791 - 095.292682
Fax (+39) 095.350135
Info@sineronline.com - www.sineronline.com



PROFILATI ESTRUSI IN LEGA DI ALLUMINIO E RELATIVI ACCESSORI PER CASSONETTI PUBBLICITARI MONOFACCIALI E BIFACCIALI

A magazzino sono normalmente disponibili i profilati e gli accessori nei colori :

ox. argento

I colori dei preverniciati sono: bianco, rosso, verde, marrone;

I profili preverniciati ed i relativi accessori non sono disponibili a magazzino;
vengono preparati solo su richiesta, con una tempistica di approntamento di circa gg.45
dall'ordine.

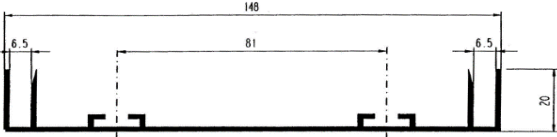
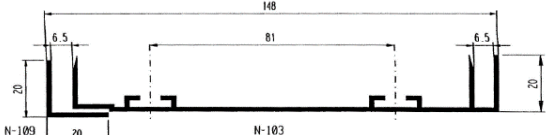
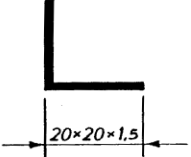
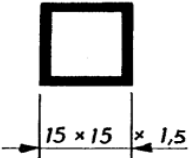
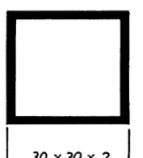
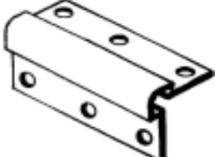
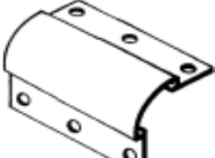
Disegno	Codice	Descrizione	
Profili			
	N107	Profilo da 150 mm	
	N103	Profilo da 150 mm	
<p>* La lunghezza disponibile delle barre è di 6,00m.</p>			
Accessori			
	N109	Profilo angolare da 20x20x1,5mm accoppiare a N103	
	N111	Profilo tubo quadro da 15x15x1,5mm di rinforzo	
	N131	Profilo tubo quadro da 30x30x2mm accoppiare a F210	
<p>* La lunghezza disponibile delle barre è di 6,00m.</p>			
	A150	Angolo per profilo da 150mm	
	C150	Curva per profilo da 150mm	

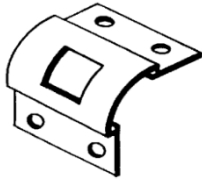
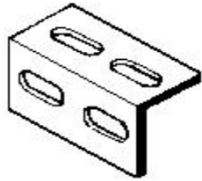
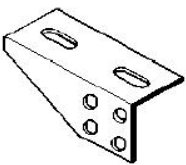
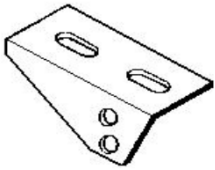
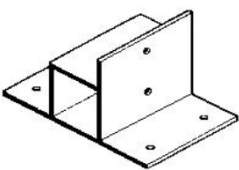
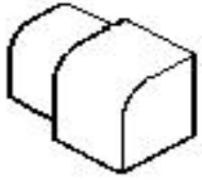
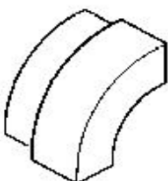
Disegno	Codice	Descrizione	Prezzo
Accessori			
	CF150	Curva con foro quadro per profilo da 150mm accoppiare a N131	
	S150	Squadretta per profilo da 150mm	
	FM150	Fazzoletto per cassonetto monofacciale per profilo da 150mm accoppiare a N111	
	FB150	Fazzoletto per cassonetto bifacciale per profilo da 150mm accoppiare a N111	
	FR150	Fazzoletto di rinforzo per cassonetto bifacc. per profili da 150mm accopp. a N131	
	T119	Tappo piccolo in ABS per angolo. Colore grigio accoppiare a A150	
	T112	Tappo grande in ABS per curva. Colore grigio accoppiare a C150	

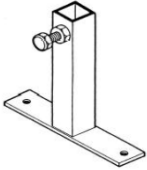
Disegno	Codice	Descrizione	
Accessori			
	B130	Vite testa quadra 13x13mm 6MA L12mm + bullone CONFEZIONE 100 PZ	
	F210	Piastra con tubolare in ferro zincato per cassonetti a bandiera accoppiare a N131	

Esempio

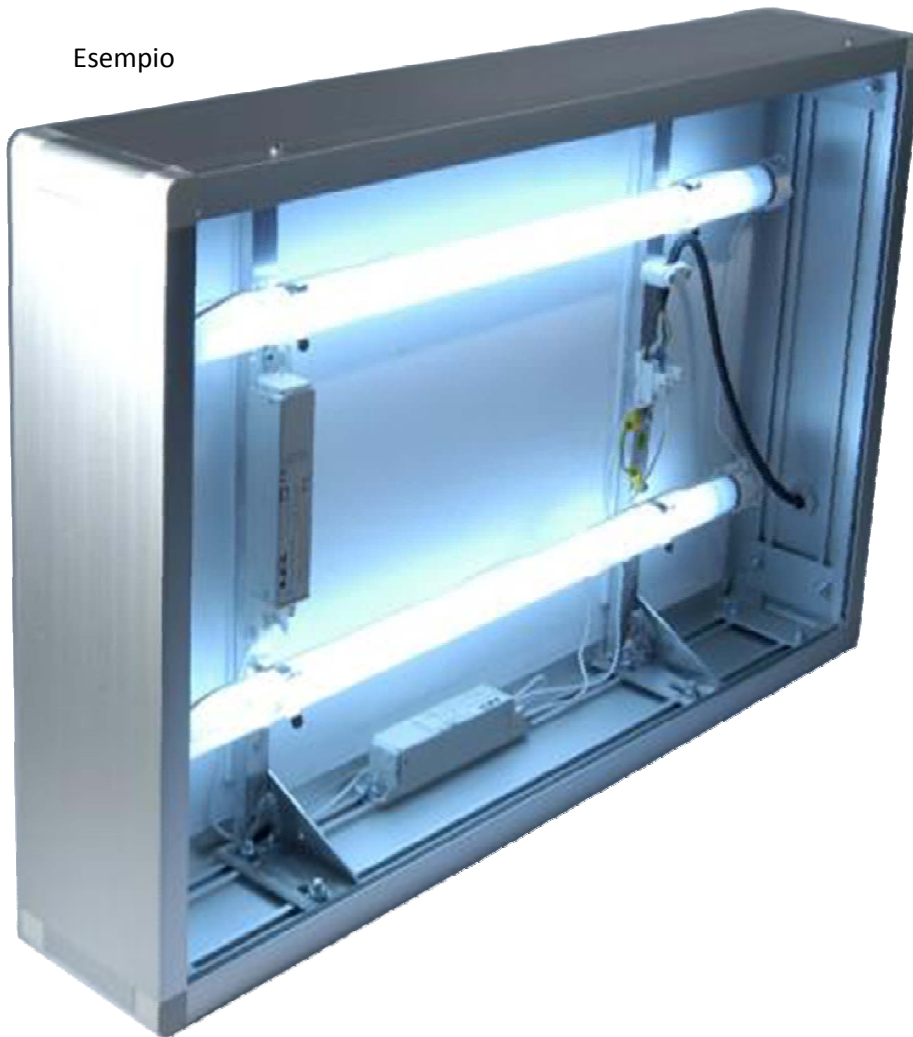

Angolo con tappo piccolo

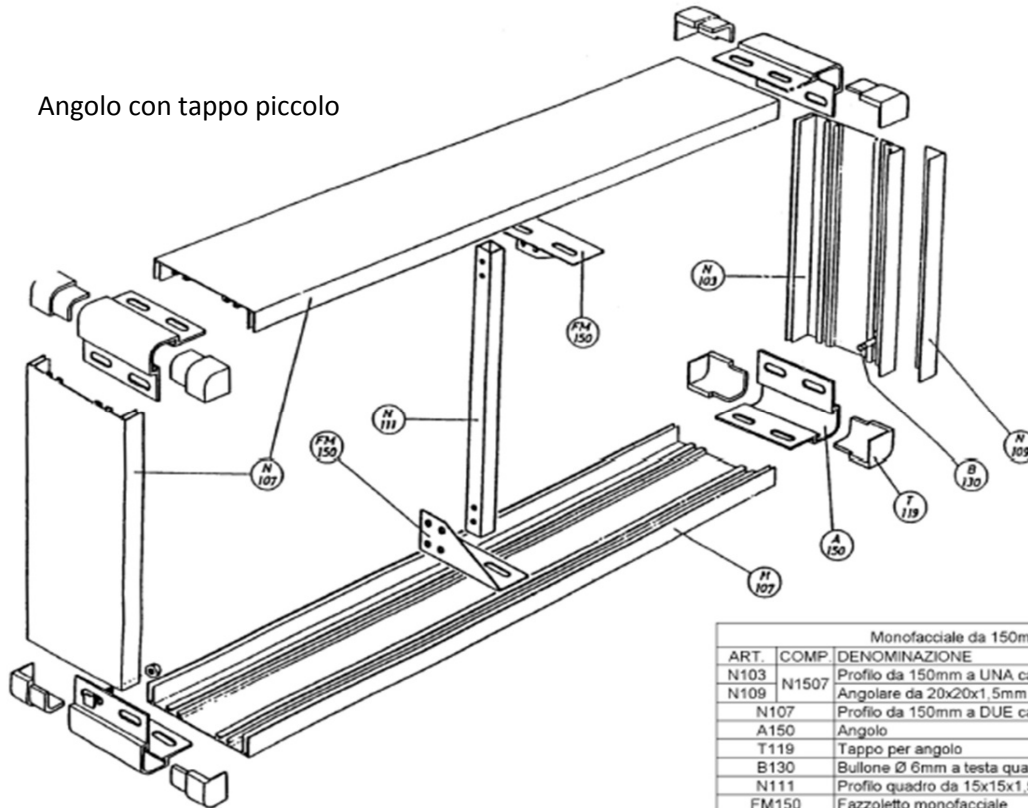

Monofacciale da 150mm			
ART.	COMP.	DENOMINAZIONE	Q. TA'
N103	N1507	Profilo da 150mm a UNA canalina	1
N109		Angolare da 20x20x1,5mm	1
N107		Profilo da 150mm a DUE canaline	3
A150		Angolo	4
T119		Tappo per angolo	8
B130		Bullone Ø 6mm a testa quadra con dado	20
N111		Profilo quadro da 15x15x1,5mm	1
FM150		Fazzoletto monofacciale	2

Curva con tappo grande

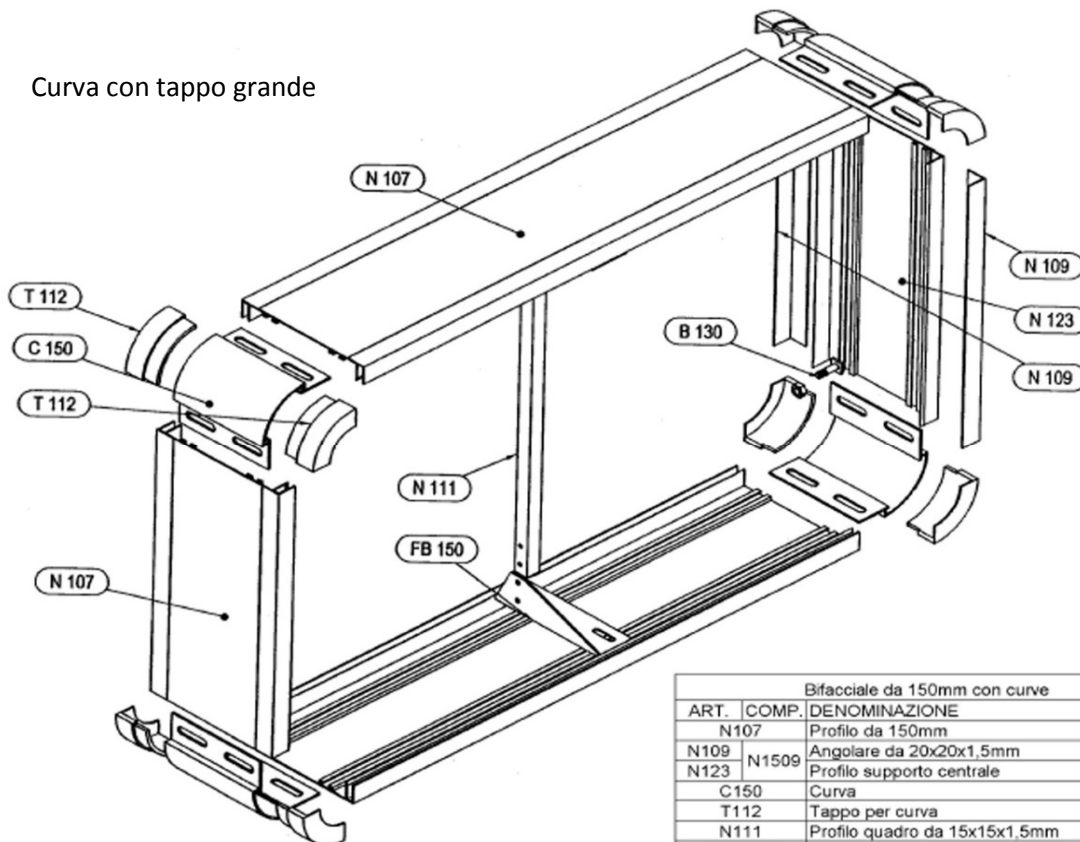

Bifacciale da 150mm con curve			
ART.	COMP.	DENOMINAZIONE	Q. TA'
N107		Profilo da 150mm	3
N109	N1509	Angolare da 20x20x1,5mm	2
N123		Profilo supporto centrale	1
C150		Curva	4
T112		Tappo per curva	8
N111		Profilo quadro da 15x15x1,5mm	1
FB150		Fazzoletto bifacciale	2
B130		Bullone Ø 6mm	20

	Codice N107	Quantità <input type="text"/>	Descrizione Profilo da 150 mm - lunghezza 6 m
--	----------------	----------------------------------	--

Quant.	Misura	Quant.	Misura	Quant.	Misura
--------	--------	--------	--------	--------	--------

	Codice N103	Quantità <input type="text"/>	Descrizione Profilo da 150 mm - lunghezza 6 m
--	----------------	----------------------------------	--

Quant.	Misura	Quant.	Misura	Quant.	Misura
--------	--------	--------	--------	--------	--------

	Codice N109	Quantità <input type="text"/>	Descrizione Profilo angolare da 20x20x1,5mm - lunghezza 6 m
--	----------------	----------------------------------	--

Quant.	Misura	Quant.	Misura	Quant.	Misura
--------	--------	--------	--------	--------	--------

	Codice N111	Quantità <input type="text"/>	Descrizione Profilo tubo quadro da 15x15x1,5mm - lunghezza 6 m
--	----------------	----------------------------------	---

Quant.	Misura	Quant.	Misura	Quant.	Misura
--------	--------	--------	--------	--------	--------

	Codice N131	Quantità <input type="text"/>	Descrizione Profilo tubo quadro da 30x30x2mm - lunghezza 6 m
--	----------------	----------------------------------	---

Quant.	Misura	Quant.	Misura	Quant.	Misura
--------	--------	--------	--------	--------	--------

ATTENZIONE !! In fase di calcolo lunghezza del profilo considerare la misura sporgente dell'angolare (spazio curvatura)

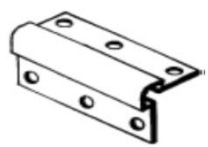
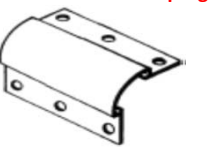
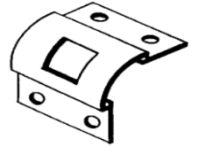
	Codice A150	Quantità <input type="text"/>		Codice C150	Quantità <input type="text"/>		Codice CF150	Quantità <input type="text"/>
		spazio curvatura 20 mm per lato			spazio curvatura 50 mm per lato			spazio curvatura 50 mm per lato

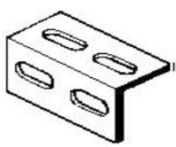
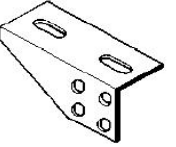
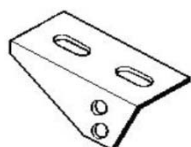
	Codice S150	Quantità <input type="text"/>		Codice FM150	Quantità <input type="text"/>		Codice FB150	Quantità <input type="text"/>
--	----------------	----------------------------------	---	-----------------	----------------------------------	---	-----------------	----------------------------------

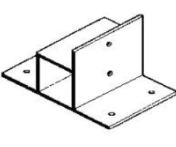
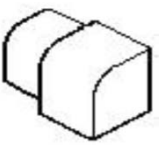
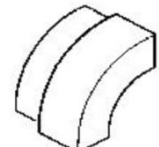
	Codice FR150	Quantità <input type="text"/>		Codice T119	Quantità <input type="text"/>		Codice T112	Quantità <input type="text"/>
--	-----------------	----------------------------------	---	----------------	----------------------------------	---	----------------	----------------------------------

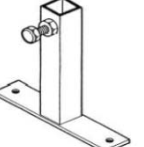
	Codice B130	Quantità <input type="text"/>		Codice F210	Quantità <input type="text"/>
		Conf 100 pz			

**FOGLIO ORDINE
DA INVIARE PER E-MAIL A:
ordini@sineronline.com**

